

(Managing Automated Vehicles Enhances Network)

# V2X communications for cooperation between vehicle and infrastructure automation

**Michele Rondinone**

Hyundai Motor Europe Technical Center GmbH, Germany



CAD + C-ITSec Workshop at the IEEE Intelligent Vehicle Symposium  
9.6.2019 Paris, France



MAVEN is funded by the EC Horizon 2020 Research and Innovation Framework Programme, under Grant Agreement No. 690727



# General Information

## □ Duration

- ✓ 36 months (Sept '16 – Aug '19)

## □ Funding

- ✓ ~3M€ under EC H2020 programme

## □ Partners:

- ✓ From five countries: DE, NL, CZ, BE, UK



Gemeente Helmond



## □ Website

- ✓ [www.maven-its.eu](http://www.maven-its.eu)

**MAVEN**



MAVEN is funded by the EC Horizon 2020 Research and Innovation Framework Programme, under Grant Agreement No. 690727





MAVEN is funded by the EC Horizon 2020 Research and Innovation Framework Programme, under Grant Agreement No. 690727



# Project summary

## Assumption

- ❑ Road infrastructure applications will still play a key role in future cooperative automated driving era

## Main objective

- ❑ Increasing traffic efficiency and safety in urban areas by exploiting automated driving

## Approach

- ❑ C-ITS infrastructure-based traffic management solutions for cooperative automated vehicles (CAVs) at signalized intersections (traffic lights) and intersection corridors
- ❑ V2X-based automated driving extensions for perception and planning
- ❑ Use of simulation verification as well as road experiments with CAV and infra prototypes (ETSI ITS G5-based)



# Use cases overview

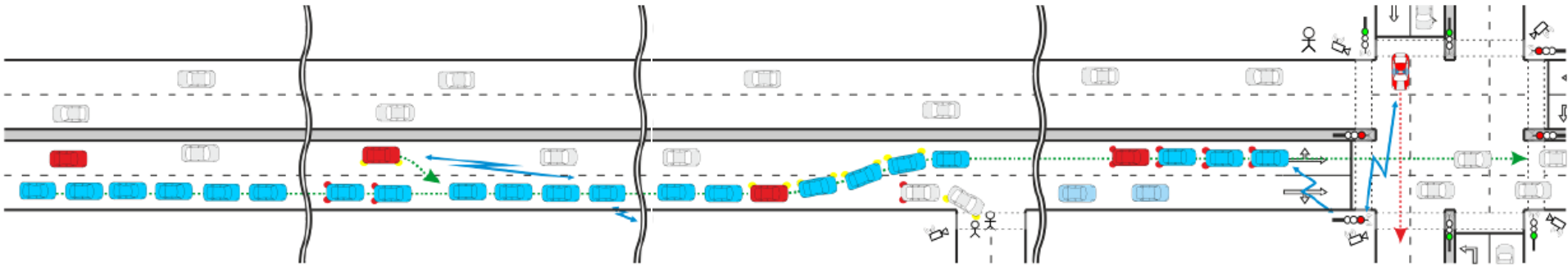

## ❑ I2V interactions

- ✓ V2I “explicit” probing + I2V speed/lane advisory + V2I feedbacks on compliance to advisories

## ❑ Traffic controllers optimization

- ✓ Signal optimization, priority management, queue estimation, green wave

## ❑ Platoon management

- ✓ Forming, joining, travelling in, leaving, breaking a platoon

## ❑ Inclusion of conventional traffic and VRUs

- ✓ Detection/reaction in presence of non-coop cars & VRUs

**MAVEN**



# MAVEN I2V interactions

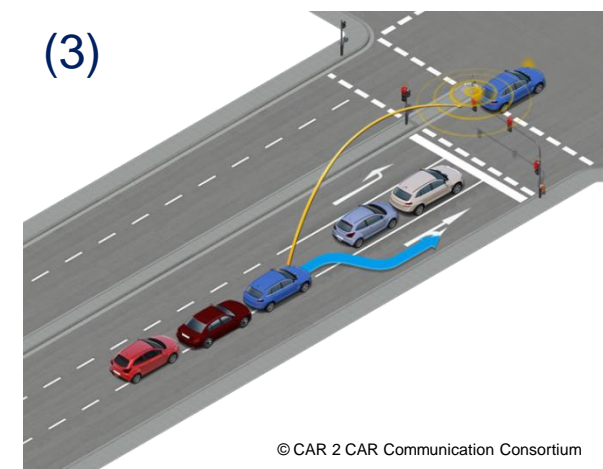
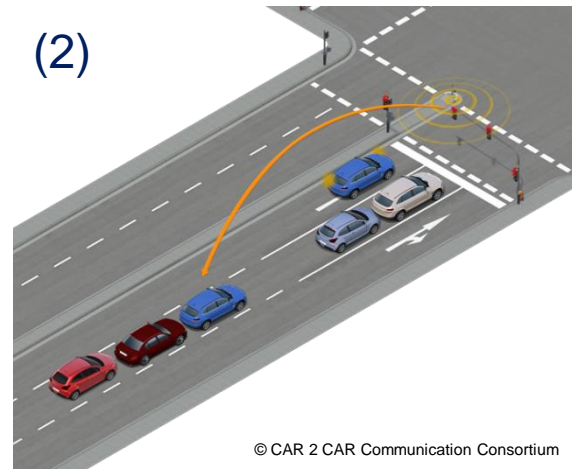
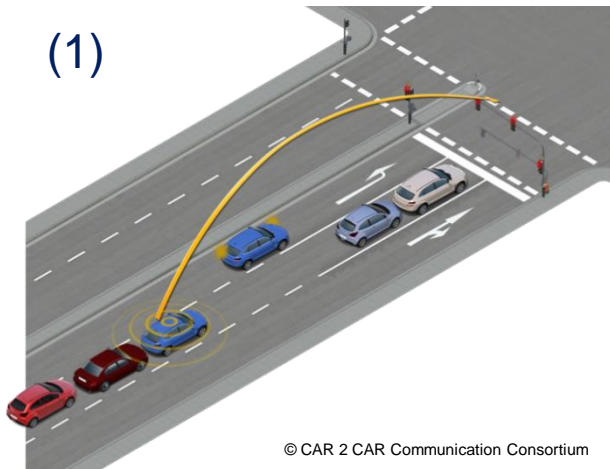

## ❑ V2I explicit traffic probing (1)

- ✓ CAVs and/or platoons transmits planned route, desired speed, platoon characteristics, etc.

## ❑ Traffic light controller signal timing re-optimization and I2V advisories (2)

- ✓ Based on rx info/calculations, infra transmits speed /lane change advisories

## ❑ V2I feedbacks on compliance to advisories (3)

- ✓ CAVs and/or platoons communicate if advisories can be executed
- ✓ If yes, traffic light controller “freezes” signal timing optimization

MAVEN



MAVEN is funded by the EC Horizon 2020 Research and Innovation Framework Programme, under Grant Agreement No. 690727





# V2X for I2V interactions (1)

(1)

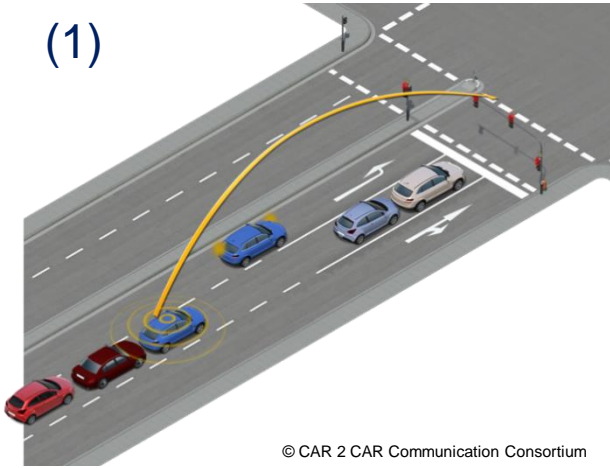

Ext CAM on SCH0	ItsPduHeader (as in [ETSI EN 302 637-2])	
	CoopAwareness	GenerationDeltaTime (as in [ETSI EN 302 637-2])
		BasicContainer (as in [ETSI EN 302 637-2], includes car position)
		HighFrequency Container = BasicVehicleContainerHighFrequency (as in [ETSI EN 302 637-2], includes dynamic info)
		LowFrequencyContainer = BasicVehicleContainerLowFrequency (as in [ETSI EN 302 637-2])
CAMParameters	SpecialVehicleContainer = MavenAutomatedVehicleContainer	

## ❑ Message for V2I traffic probing

- ✓ Backward-compatible extension of CAM (on Day1 SCH0)
- ✓ MavenAutomatedVehicleContainer includes info needed by TLC
  - ✓ CAV route at intersection (e.g. Ingress/egress lane)
  - ✓ Distance to preceding/following vehicle
  - ✓ Platoon id (tx by platoon leader if platoon is present)
  - ✓ Platoon participants (tx by platoon leader if platoon is present)
  - ✓ Desired platoon speed (tx by platoon leader if platoon is present)
  - ✓ ...

**MAVEN**



MAVEN is funded by the EC Horizon 2020 Research and Innovation Framework Programme, under Grant Agreement No. 690727



# V2X for I2V interactions (2)

(2)

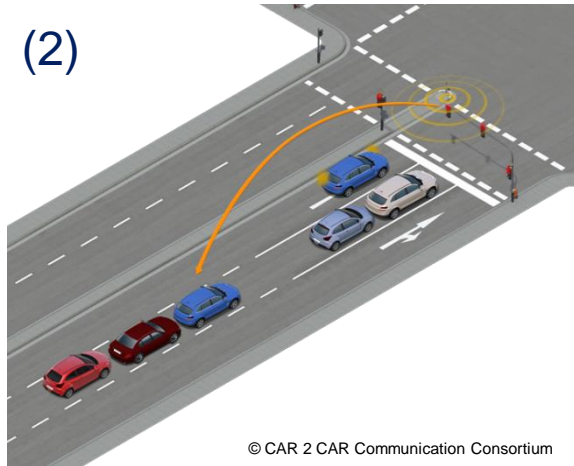

## Messages for I2V advisories

- ✓ Lane-specific GLOSA
  - ✓ Suggests speed to be adopted on a given lane, calculated based on queue estimation
  - ✓ Use current standard SPATEM/MAPEM profiled to allocate lane-specific signal groups when needed
- ✓ Lane change advice message
  - ✓ Suggests the lane a CAV or platoon should change to at an intersection
  - ✓ Indicates target lane, distance to stop line, and time for starting the maneuver
  - ✓ Uses a newly defined Lane Advisory Message (LAM) including individual advices

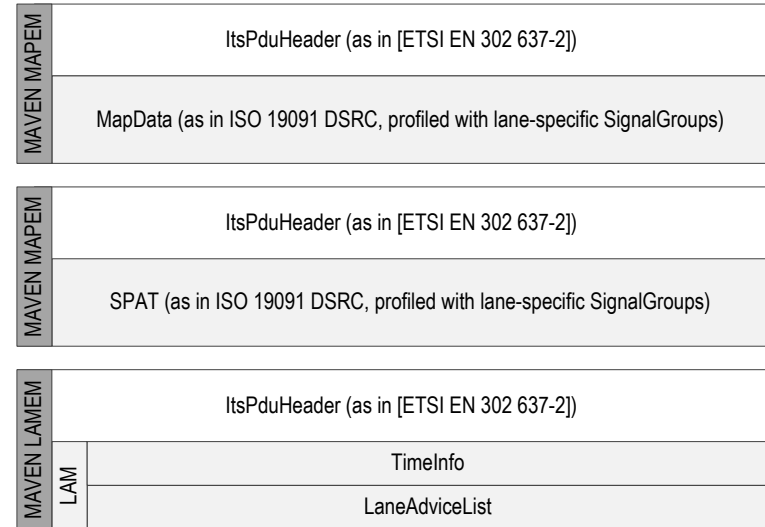

MAVEN





# V2X for I2V interactions (3)

(3)

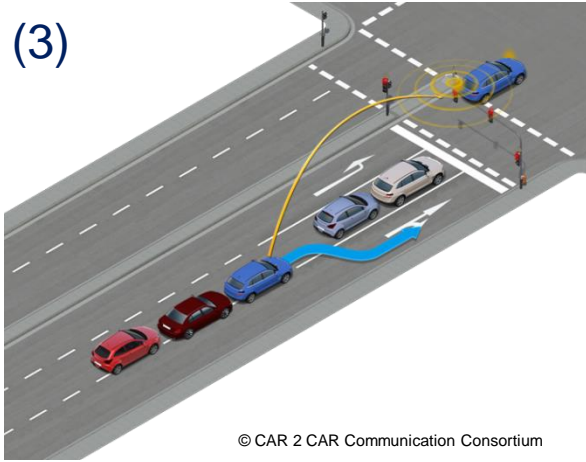

© CAR 2 CAR Communication Consortium

Ext CAM on SCH0	ItsPduHeader (as in [ETSI EN 302 637-2])	
	GenerationDeltaTime (as in [ETSI EN 302 637-2])	
	CoopAwareness CAMParameters	BasicContainer (as in [ETSI EN 302 637-2], includes car position)
		HighFrequency Container = BasicVehicleContainerHighFrequency (as in [ETSI EN 302 637-2], includes dynamic info)
		LowFrequencyContainer = BasicVehicleContainerLowFrequency (as in [ETSI EN 302 637-2])
SpecialVehicleContainer = MavenAutomatedVehicleContainer		

## ❑ Message for V2I feedbacks on compliance to advisories (3)

- ✓ Backward compatible extension of CAM message (on Day1 SCH0)
- ✓ MavenAutomatedVehicleContainer includes feedback needed by TLC
  - ✓ Real-time Acknowledgment on whether the GLOSA is being applied by the CAV
  - ✓ Real-time Acknowledgment on whether the lane change is being executed by the CAV

MAVEN



MAVEN is funded by the EC Horizon 2020 Research and Innovation Framework Programme, under Grant Agreement No. 690727



# MAVEN platooning

(1)

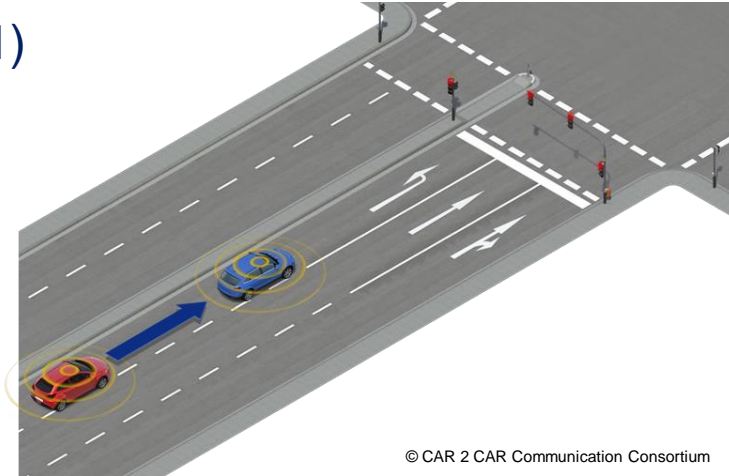

(2)

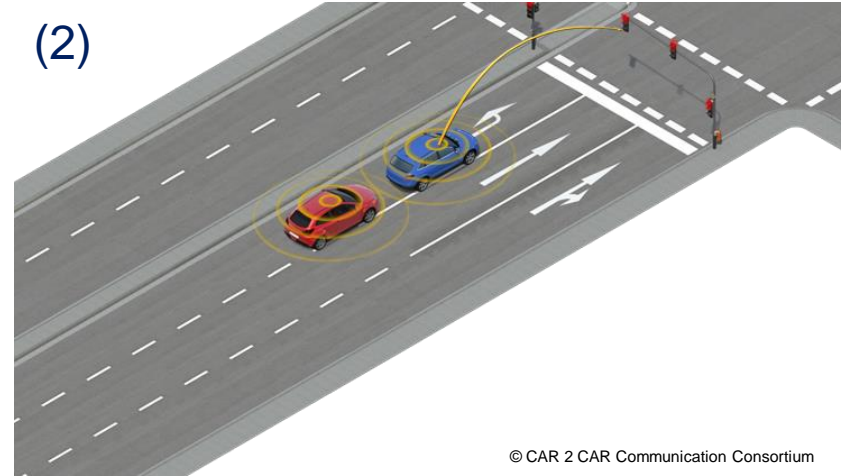

## ❑ Mix between distributed and centralized approach

- ✓ Based on common distributed algorithm and V2V exchanged info, individual vehicles form platoons and manage their operation (joining, leaving, etc.) (1)
- ✓ Yet, platoon leader has the central role of communicating platoon features to the infra for explicit traffic probing (2)

## ❑ Use of 2 parallel ITS G5 channels

- ✓ One for advertising vehicle and/or platoon characteristics to other vehicles or infra
- ✓ The other, to convey more frequent platoon control and management info

MAVEN

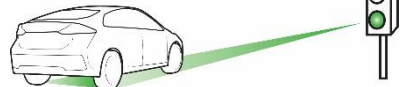

MAVEN is funded by the EC Horizon 2020 Research and Innovation Framework Programme, under Grant Agreement No. 690727



# V2X for MAVEN platooning

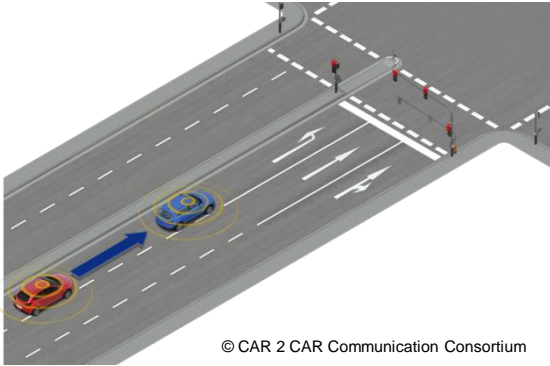

© CAR 2 CAR Communication Consortium

Ext CAM on SCH0	CoopAwareness	CAMPParameters	ItsPduHeader (as in [ETSI EN 302 637-2])
			GenerationDeltaTime (as in [ETSI EN 302 637-2])
			BasicContainer (as in [ETSI EN 302 637-2], includes car position)
			HighFrequency Container = BasicVehicleContainerHighFrequency (as in [ETSI EN 302 637-2], includes dynamic info)
			LowFrequencyContainer = BasicVehicleContainerLowFrequency (as in [ETSI EN 302 637-2])
SpecialVehicleContainer = MavenAutomatedVehicleContainer			

Ext CAM on SCHx	CoopAwareness	CAMPParameters	ItsPduHeader (as in [ETSI EN 302 637-2])
			GenerationDeltaTime (as in [ETSI EN 302 637-2])
			BasicContainer (as in [ETSI EN 302 637-2], includes car position)
			HighFrequency Container = AutomatedVehicleContainerHighFrequency
			LowFrequencyContainer = AutomatedVehicleContainerLowFrequency

## ❑ Message for platooning initialization

- ✓ Backward compatible extension of CAM message (on Day1 SCH0)
- ✓ MavenAutomatedVehicleContainer carries info for CAVs to detect opportunities for building/joining a platoon (e.g. Based on same expected route, desired speed, etc)

## ❑ Message for platooning management and control

- ✓ CAM tx on a parallel SCH with higher frequency [fixed 10Hz]
- ✓ Carries limited set of info
  - ✓ for platoon control (e.g. Planned path, position, speed, acceleration, heading)
  - ✓ for platoon management: joining, brake-up, termination (e.g. flags representing the vehicle status in the platoon and used by the platoon logic)

**MAVEN**



MAVEN is funded by the EC Horizon 2020 Research and Innovation Framework Programme, under Grant Agreement No. 690727



# Inclusion of conventional traffic and VRUs

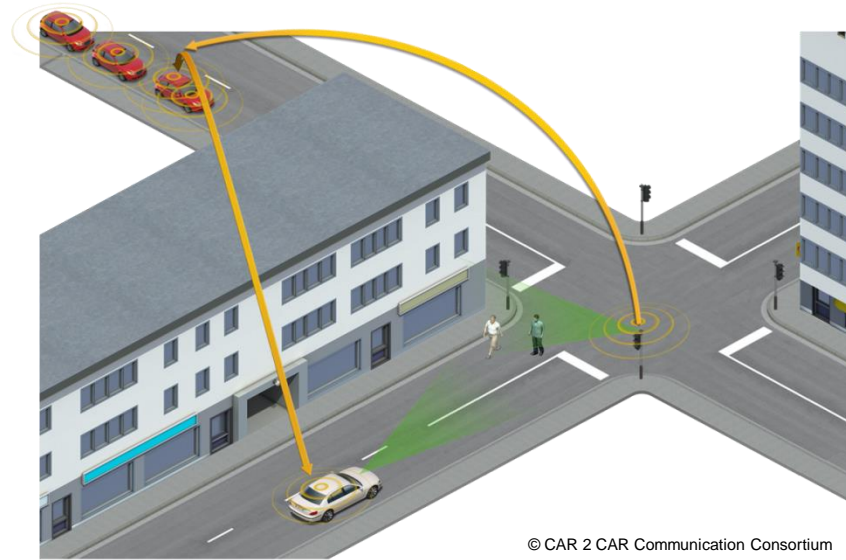

## □ Use of collective perception for improved detection and reaction

- ✓ Both CAVs and infra can detect and share info about non-cooperative road users
- ✓ Improved awareness used to adapt CAV maneuver/path planning for increased safety
- ✓ Isolated CAVs or CAVs in platoon keep monitoring the environment and control the system all the time to possibly undertake emergency (automated) reactions

**MAVEN**



MAVEN is funded by the EC Horizon 2020 Research and Innovation Framework Programme, under Grant Agreement No. 690727



# V2X for inclusion of conventional traffic & VRUs

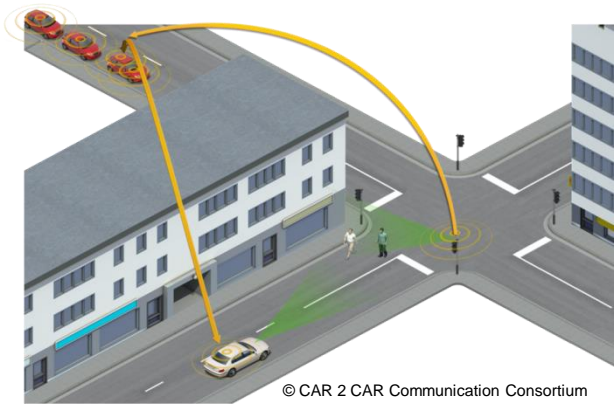

CPM	ItsPduHeader (as in [ETSI EN 102 894-2])	
	Collective Perception CPMParameters	GenerationDeltaTime (as in [ETSI EN 302 637-2])
		OriginatingStationContainer
		SensorInformationContainer
PerceivedObjectContainer		

## Message for collective perception

- ✓ Adoption of Collective Perception Message (CPM) in pre-standardization at ETSI ITS (TR 103 562 and TS 103 324 ) and consideration at the C2C-CC
- ✓ Active contribution to ETSI CPM standardization to accommodate MAVEN requirements
  - ✓ General restructuring of CPM to accommodate detections from RSUs
  - ✓ Definitions based on RSU-specific reference system in all containers
  - ✓ Possibility to match detected objects to topological information transmitted in MAP messages

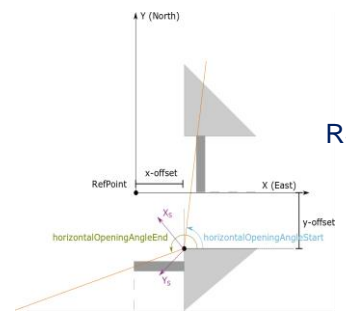
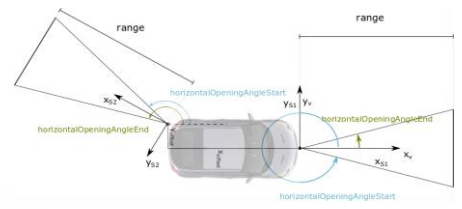

**MAVEN**

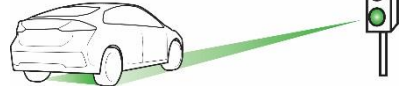

MAVEN is funded by the EC Horizon 2020 Research and Innovation Framework Programme, under Grant Agreement No. 690727



# Verification schemes

## □ Lab testing with V2X HW integration

- ✓ Target: verify V2X protocols functionality and interaction with AD SW modules
- ✓ Real V2X HW is used
- ✓ AD SW modules connected but run on lab PC (not in real car prototype)

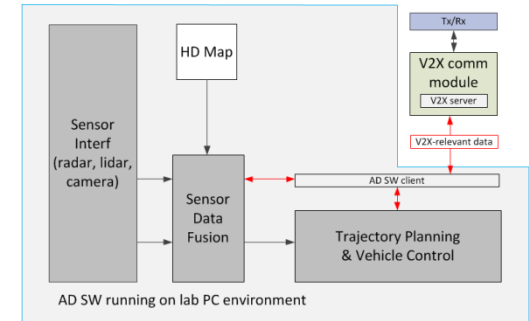

## □ Field testing with V2X emulation

- ✓ Target: verify AD SW functionality in reaction to V2X inputs
- ✓ AD SW & HW on real car prototype used
- ✓ V2X protocols are emulated and run as part of AD SW

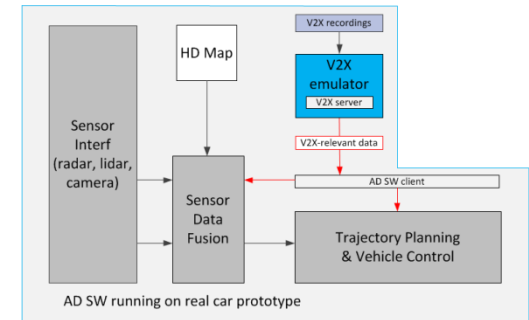

## □ Field testing with V2X HW integration

- ✓ Target: jointly verify AD SW and V2X protocols functionality
- ✓ Both V2X and AD SW & HW on real car prototype

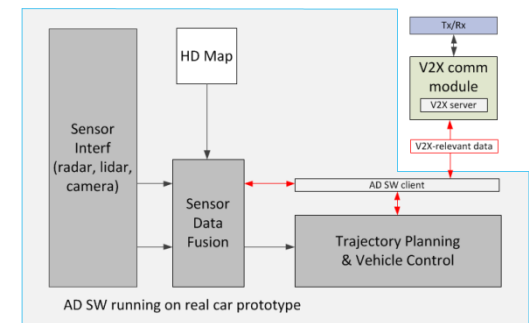



# Lab testing with V2X integration

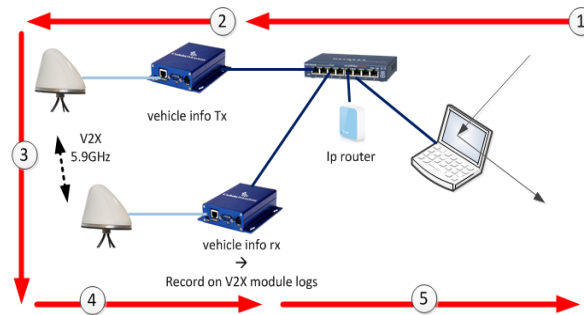
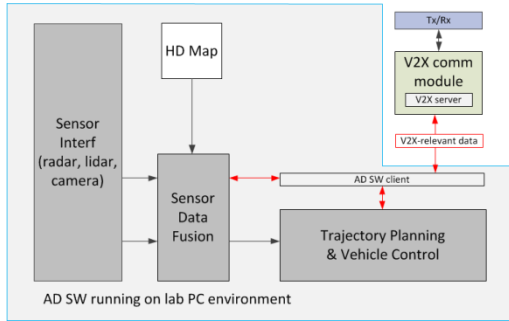

- 1) Injection of AD data at AD SW client
- 2) Coding of V2X messages according to MAVEN protocols
- 3) Transmission and reception of messages
- 4) Decoding of V2X messages according to MAVEN protocols
- 5) Reception of AD data at AD SW client, extraction and reuse in AD SW modules

## Test setup and procedure

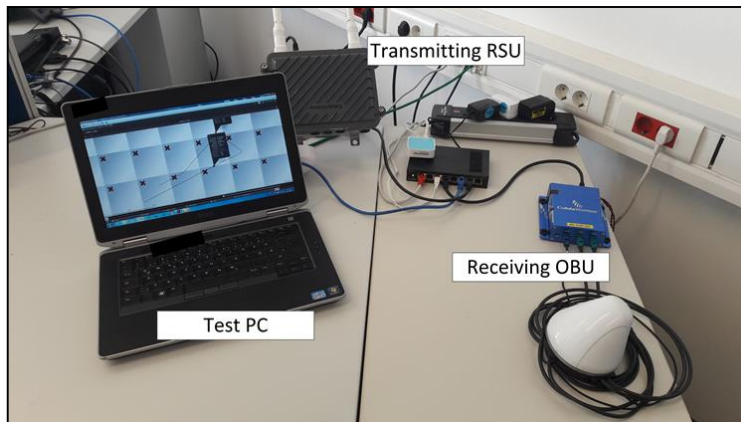

Hyundai tests

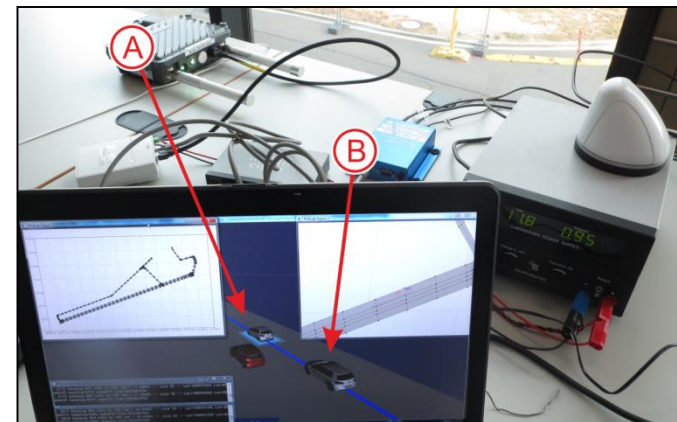

DLR tests



# Field testing with V2X emulation (1)

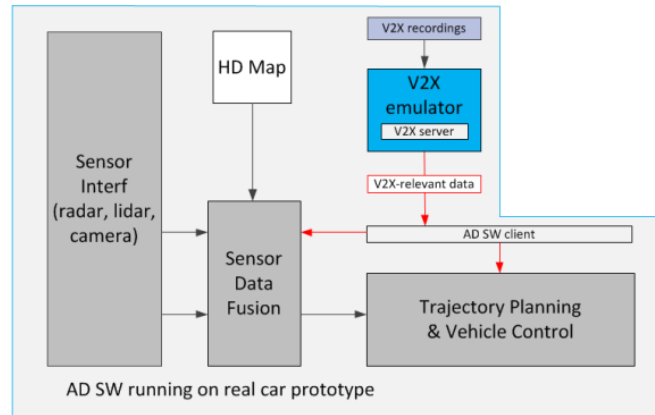

## Test setup and procedure



1) V2X data collection in real field for later reuse as recorded inputs

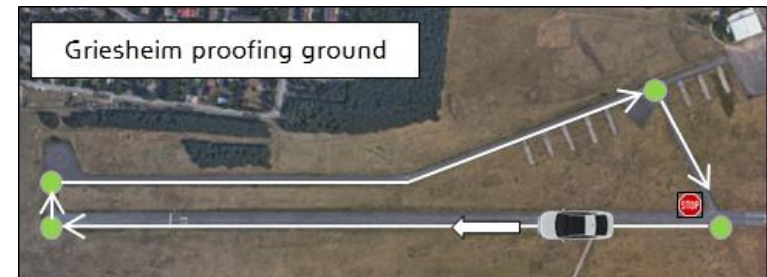

2) V2X recording replay as input for AD tests on test track

**MAVEN**



# Field testing with V2X emulation (2)

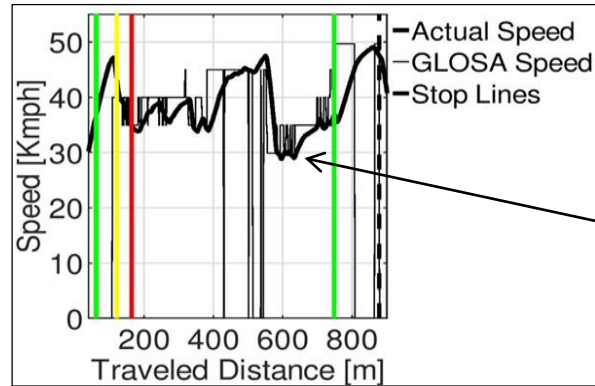

Car adapts to advised GLOSA and crosses the stop lines on green light

Hyundai GLOSA adaptation tests

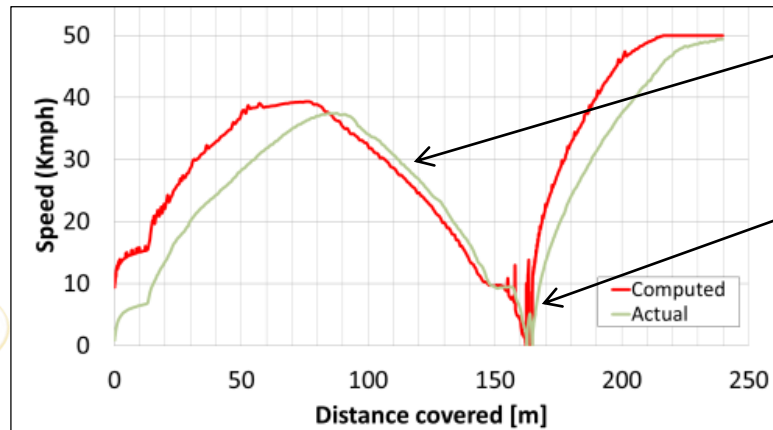
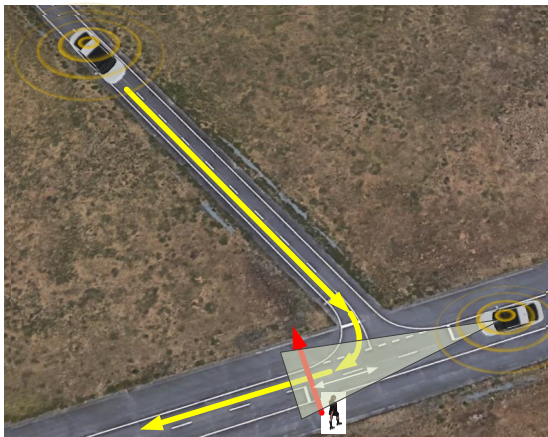

Car knows about VRU (via V2X), smoothly slows down while turning

Car detects VRU in time with own sensors, brakes and prevents collision, speeds up again after VRUs crosses

Hyundai tests on automated reaction to collective perception messages

**MAVEN**



MAVEN is funded by the EC Horizon 2020 Research and Innovation Framework Programme, under Grant Agreement No. 690727





# Field testing with V2X integration (1)

Hyundai + Dynniq tests on GLOSA and lane change in real traffic scenario



**HYUNDAI**  
MOTOR GROUP  
EUROPEAN TECHNICAL CENTER



```
***LANE CHANGE ADVISORY***  
CURRENT LANE INDEX : 0  
REQUESTED LANE INDEX : 3  
DISTANCE TRAVELLED : 126.673  
ORIGINATING LEADER : ACTUAL GAP: Not Available AND DESIRED GAP : Not Available  
LEFTLANE LEADER : ACTUAL GAP: 32.1802 AND DESIRED GAP : 37.1852  
LEFTLANE FOLLOWER : ACTUAL GAP: 18.9122 AND DESIRED GAP : 20.3045  
RIGHTLANE LEADER : ACTUAL GAP: Not Available AND DESIRED GAP : Not Available  
RIGHTLANE FOLLOWER : ACTUAL GAP: Not Available AND DESIRED GAP : Not Available  
TARGET DISTANCE TO LANE CHANGE : 180  
DISTANCE TO INITIATE LANE CHANGE : 123  
LANE CHANGE STATUS : Not Available
```



MAVEN is funded by the EC Horizon 2020 Research and Innovation Framework Programme, under Grant Agreement No. 690727



# Field testing with V2X integration (2)

DLR + Hyundai tests on platooning and GLOSA in real traffic scenario

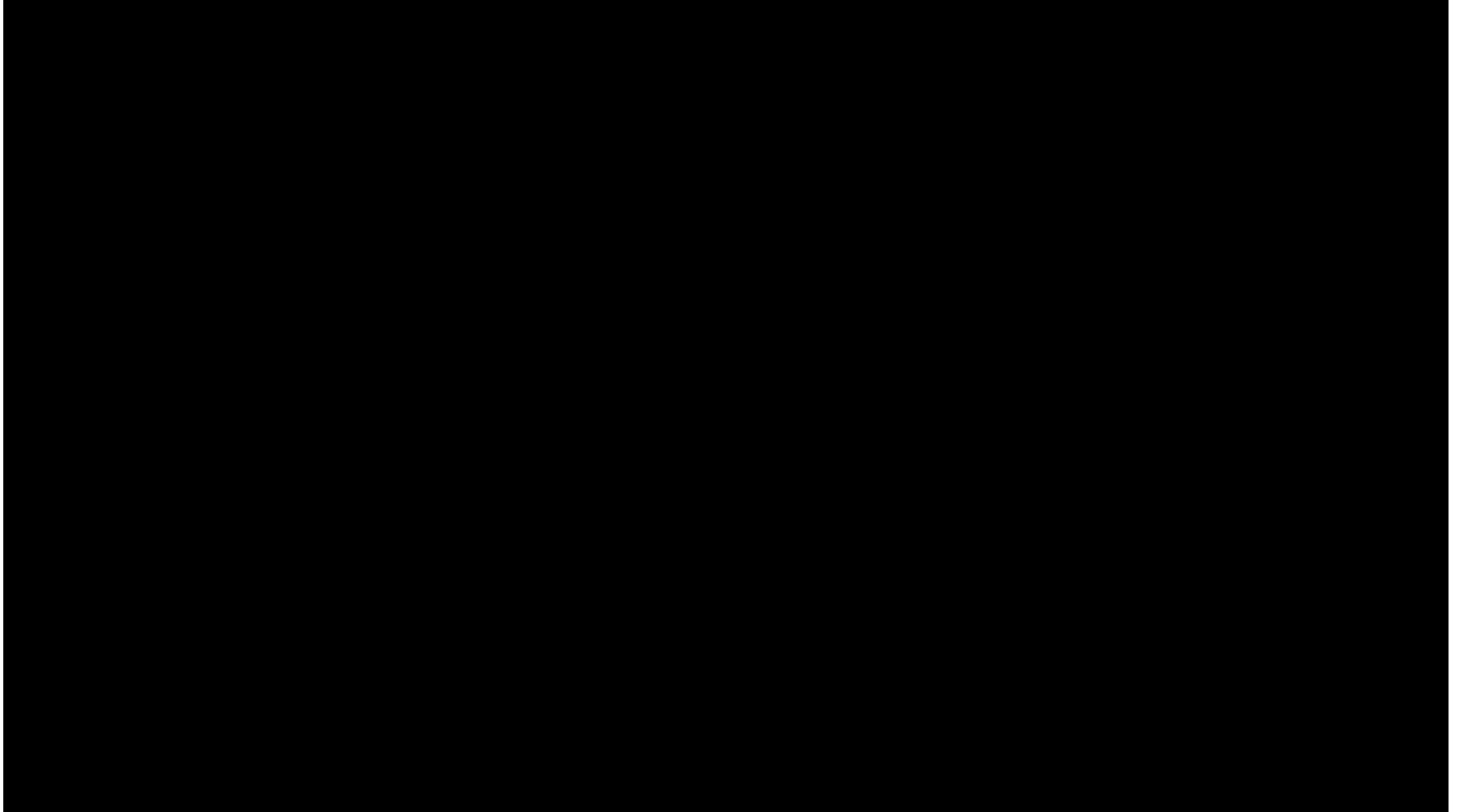

**MAVEN**



MAVEN is funded by the EC Horizon 2020 Research and Innovation Framework Programme, under Grant Agreement No. 690727



**Additional information can be found at:**

**[www.maven-its.eu](http://www.maven-its.eu)**

**Do not hesitate to contact us!**

**Thank you!**

**Questions?**



MAVEN is funded by the EC Horizon 2020 Research and Innovation Framework Programme, under Grant Agreement No. 690727

